

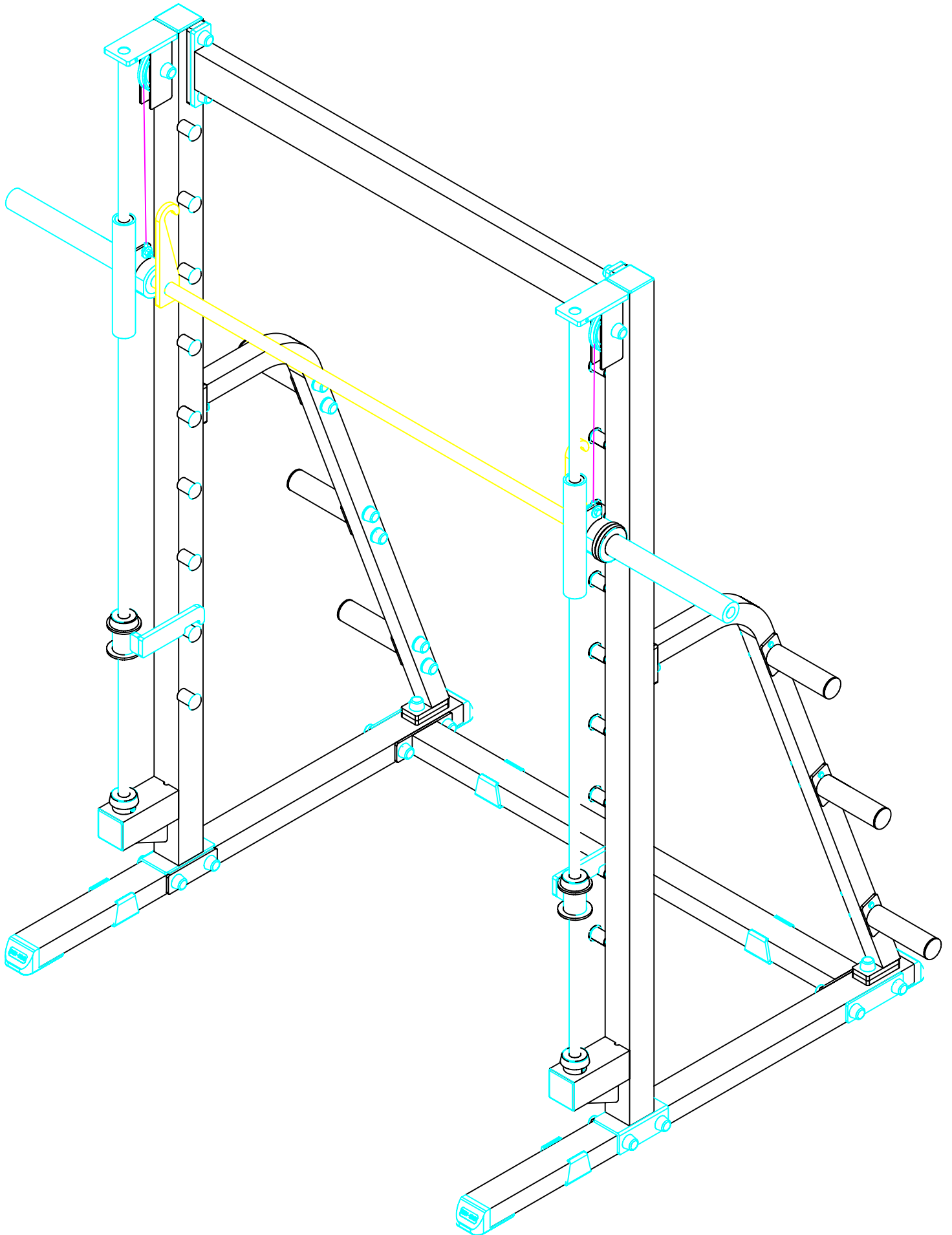

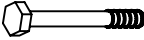

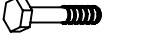





SSM-350.1



VERSION 0009

SSM-350.1 HARDWARE ILLUSTRATION SHEET

	Qty.
 A1. 1/2"X4" HEX HEAD BOLT -----	[8PCS]
 A2. 1/2"X2 1/2" HEX HEAD BOLT ----	[12PCS]
 A3. 1/2"X2" HEX HEAD BOLT -----	[2PCS]
 A4. 1/2"X1" HEX HEAD BOLT -----	[8PCS]
 A5. 3/8"X1" HEX HEAD BOLT -----	[2PCS]
 B1. 1/2" NYLON LOCK NUT -----	[10PCS]
 B2. 3/8" NYLON LOCK NUT -----	[2PCS]
 C1. 1/2" ROUND END CAP WASHER ---	[40PCS]
 C2. 1/2" (I.D)WASHER -----	[12PCS]
 C3. 3/8" (I.D)WASHER -----	[4PCS]
 C4. 1/2" SPRING WASHER -----	[8PCS]

	Qty.
D1. 1/2" BOLT CAP -----	[40PCS]
D2. ø2 1/2"X19t RUBBER DOUNT(9310-012)----	[4PCS]
D3. ø90X10t RUBBER DOUNT (9310-016)-----	[4PCS]
D4. ø3/4" RUBBER DOUNT (9212-006)-----	[18PCS]
D5. ø50 ROUND END CAP (9211-020) -----	[6PCS]
D6. ø4 1/2 " PULLEY (9213-010)-----	[2PCS]
D7. 75X75 END CAP (9211-007)-----	[4PCS]
D8. 50X75 FOOT CAP (9211-026)-----	[4PCS]
D9. 2"X3" RUBBER DOUNT (9212-011)-----	[4PCS]
D10. 2020mm STEEL CABLE-----	[2PCS]

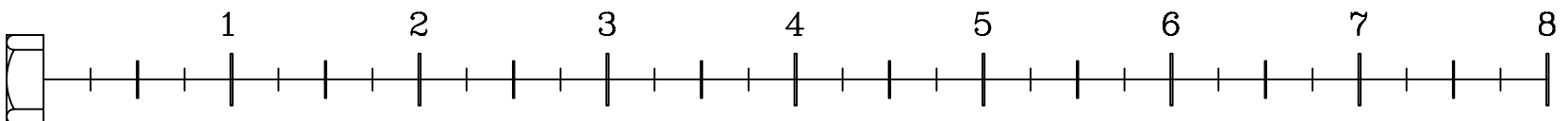
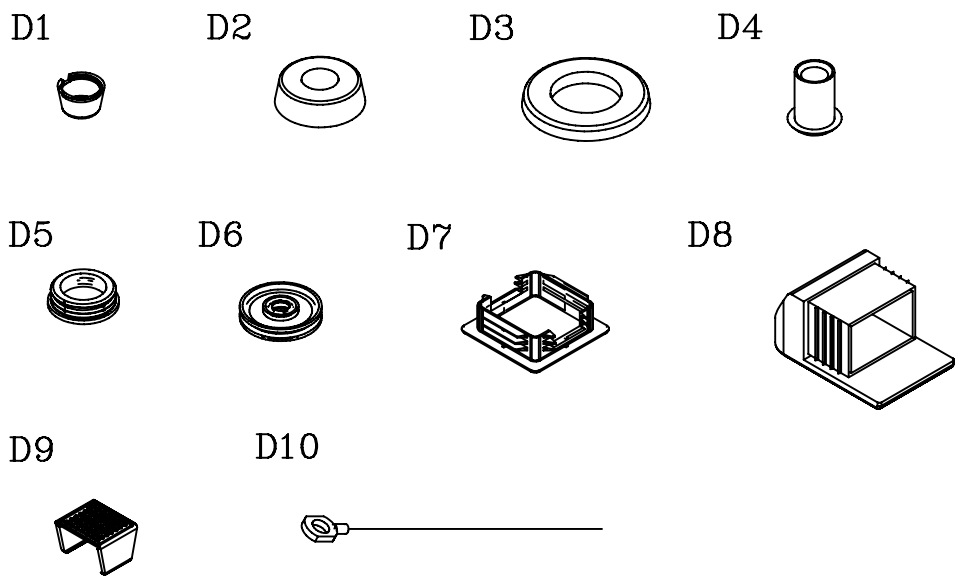

A [2PCS]

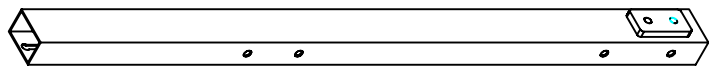

G [1PCS]

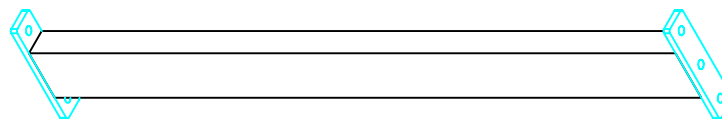

L [2PCS]



B [2PCS]



C [1PCS]

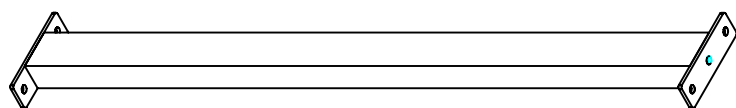

J [1PCS]



D-1 [1PCS]

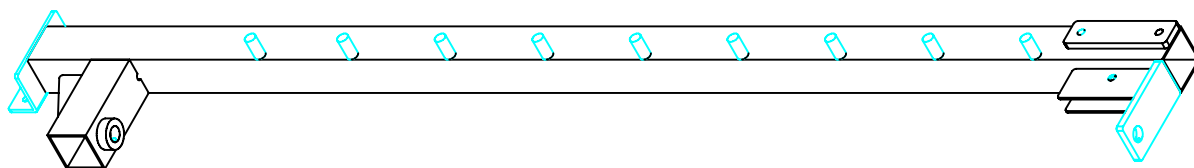

H [1PCS]

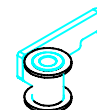

I [1PCS]

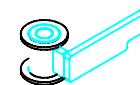

K [6PCS]

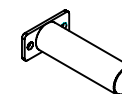

E-1 [1PCS]

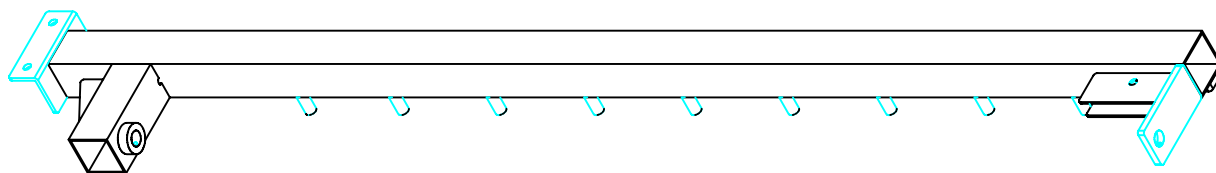

M [2PCS]



N [2PCS]



F [2PCS]

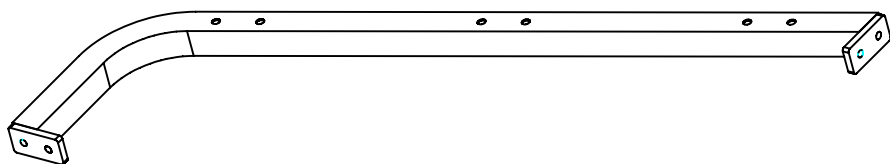

SSM-350.1

While assembling the smith machine it is very important , that while placing the linear bearing covering the on rod (B). You do so as straight as possible. Failing to do so may cause damage to the linear bearings.

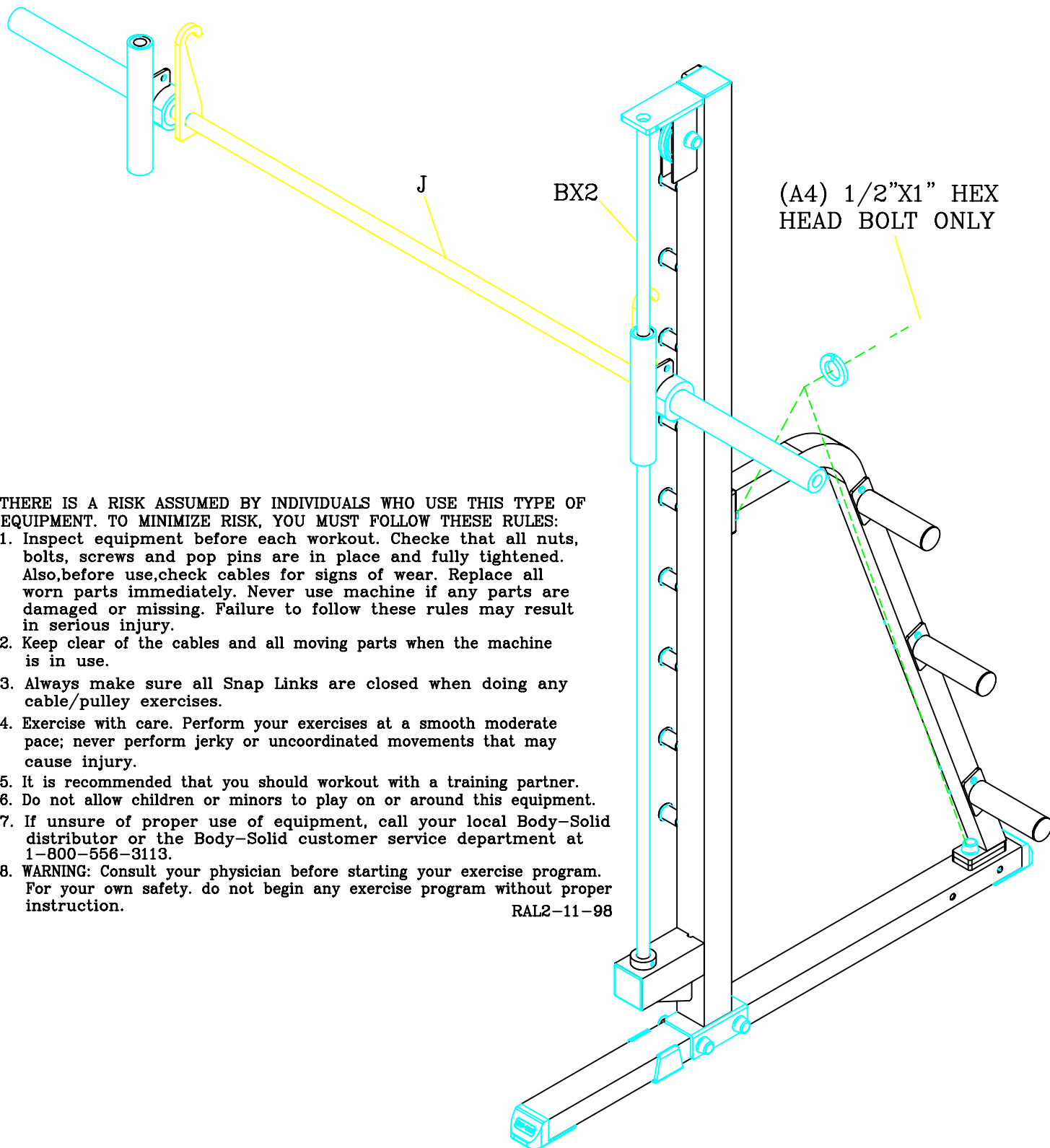

THERE IS A RISK ASSUMED BY INDIVIDUALS WHO USE THIS TYPE OF EQUIPMENT. TO MINIMIZE RISK, YOU MUST FOLLOW THESE RULES:

1. Inspect equipment before each workout. Check that all nuts, bolts, screws and pop pins are in place and fully tightened. Also, before use, check cables for signs of wear. Replace all worn parts immediately. Never use machine if any parts are damaged or missing. Failure to follow these rules may result in serious injury.
2. Keep clear of the cables and all moving parts when the machine is in use.
3. Always make sure all Snap Links are closed when doing any cable/pulley exercises.
4. Exercise with care. Perform your exercises at a smooth moderate pace; never perform jerky or uncoordinated movements that may cause injury.
5. It is recommended that you should workout with a training partner.
6. Do not allow children or minors to play on or around this equipment.
7. If unsure of proper use of equipment, call your local Body-Solid distributor or the Body-Solid customer service department at 1-800-556-3113.
8. **WARNING:** Consult your physician before starting your exercise program. For your own safety, do not begin any exercise program without proper instruction.

RAL2-11-98